

Readout Update

Justin Stevens

PID Upgrade Meeting: 4.2.15

Overview

- * MCP-PMTs from LAPPD: first preference with excellent timing resolution to improve PID capabilities, but not yet in large scale production
- * CLAS12 RICH in Hall B: very similar readout requirements for single PEs
 - * Extensive R&D with Hamamatsu 8500 and 12700 MaPMTs (6x6 mm² pixel)
 - * Developed suitable electronics, compatible with GlueX DAQ
 - * But... more expensive and worse timing resolution than MCP-PMTs

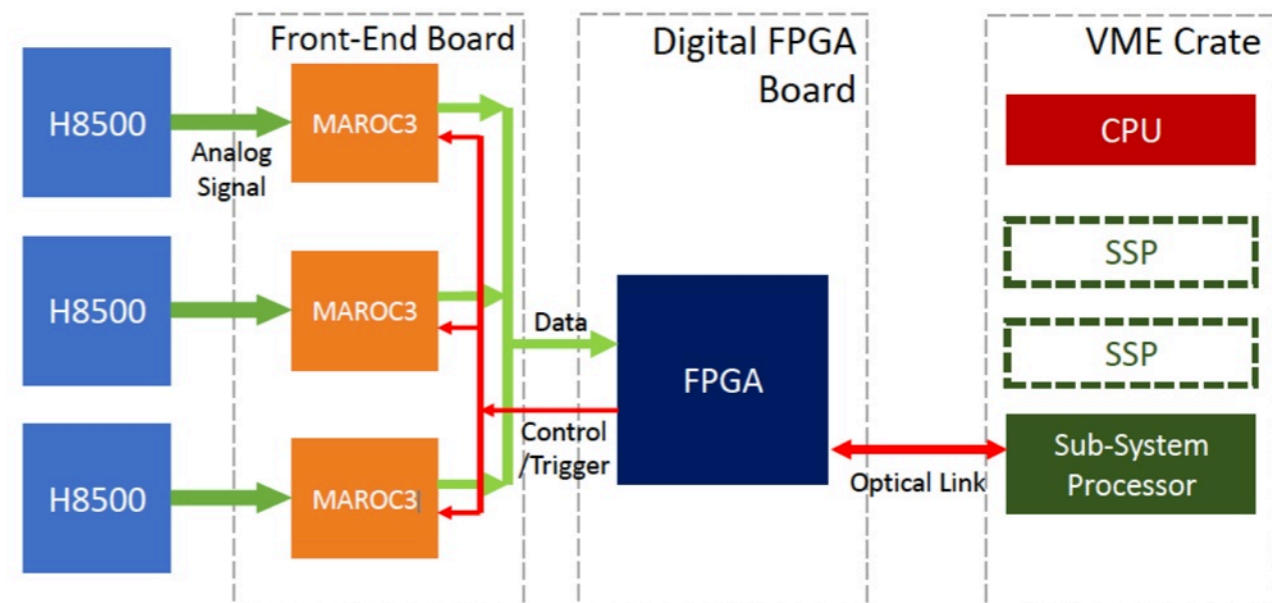
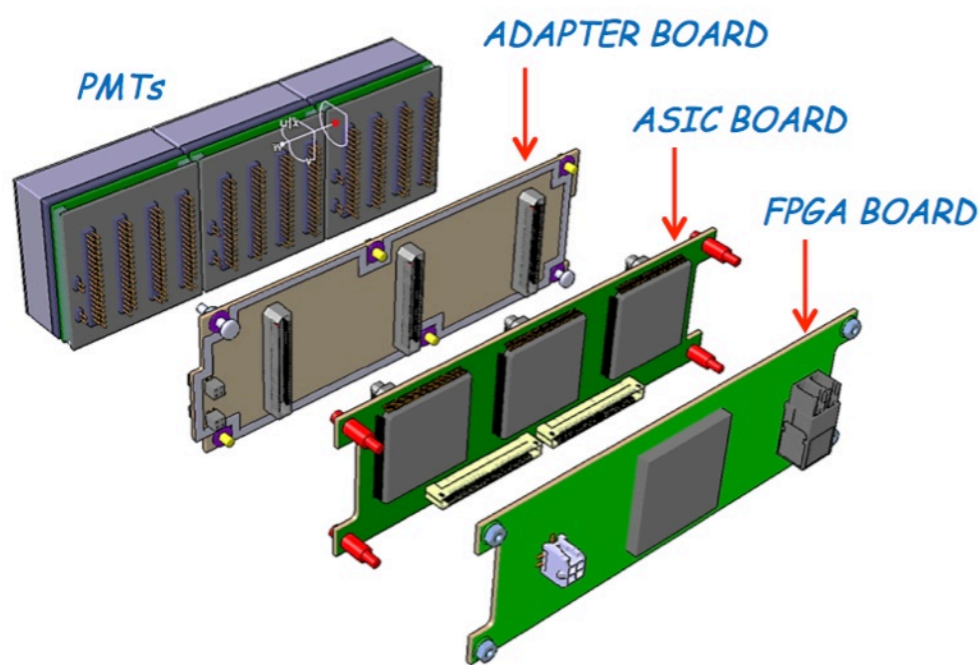

MA-PMT Photon Detector

110 Hamamatsu MAPMT out of 430 delivered and tested at JLab

- 80 H8500
 - 30 H12700 with enhanced SPE spectrum
- Procurement secured for new H12700 PMTs

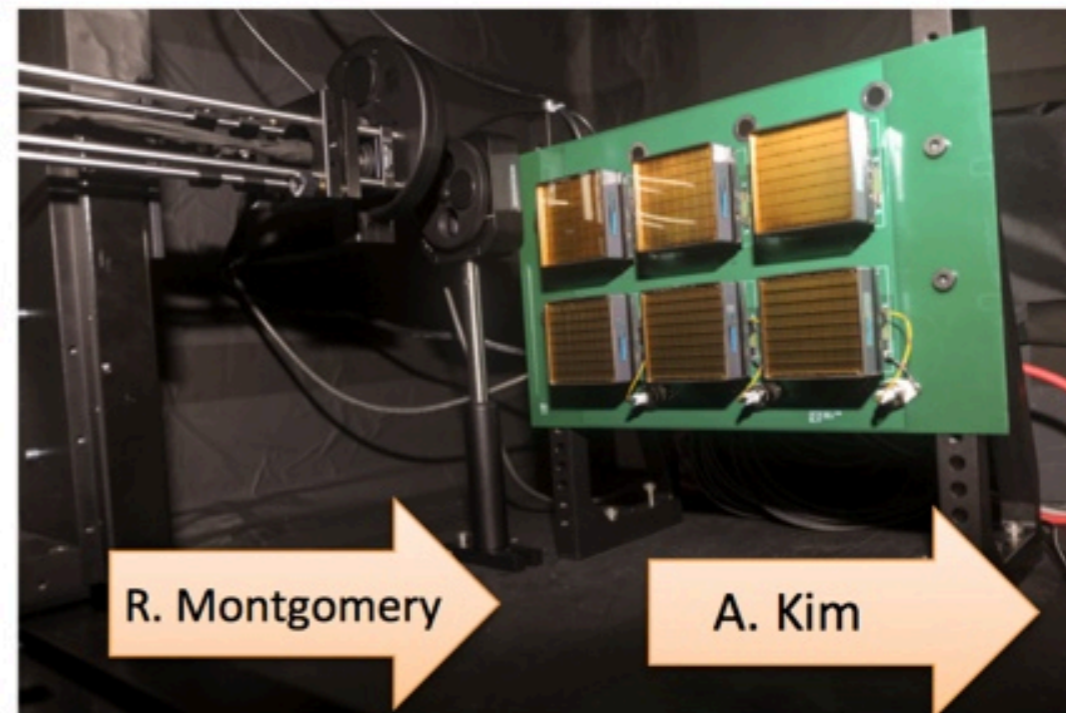

PMT Efficiency Comparison:

H12700 ↔ **H8500**

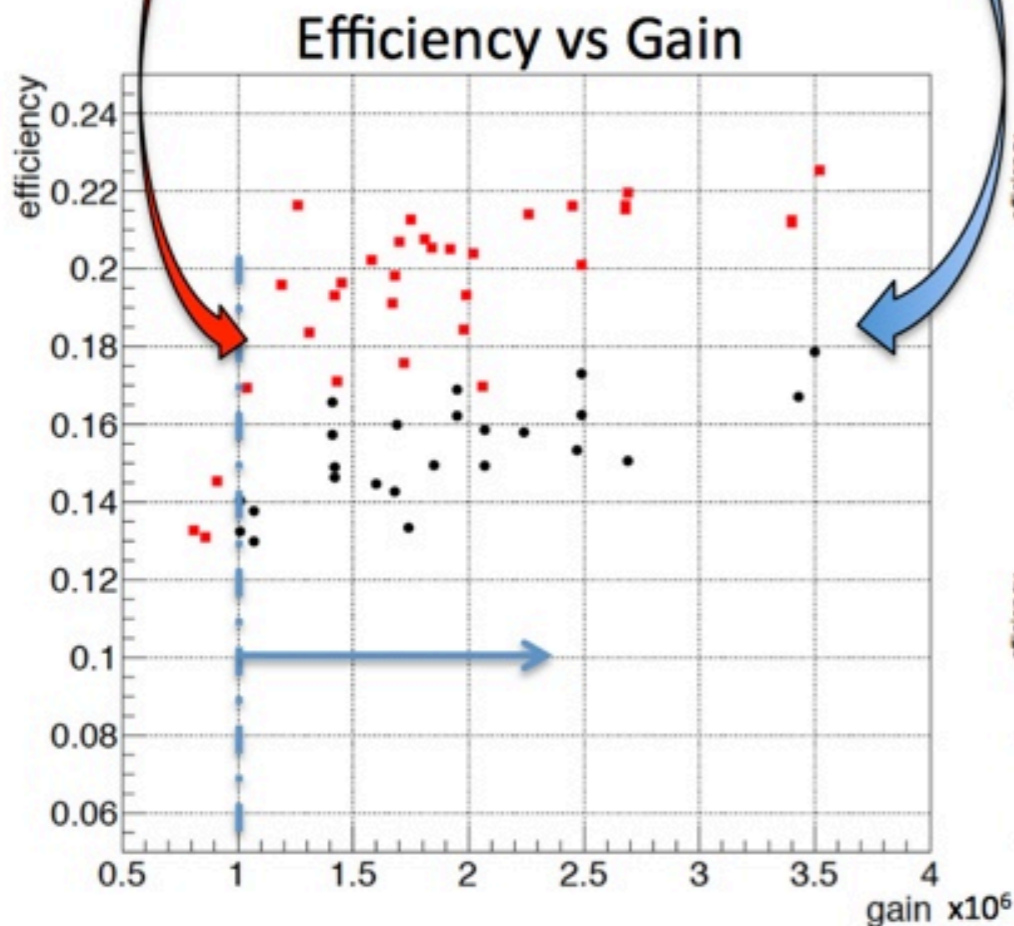

Efficiency vs Pixel number

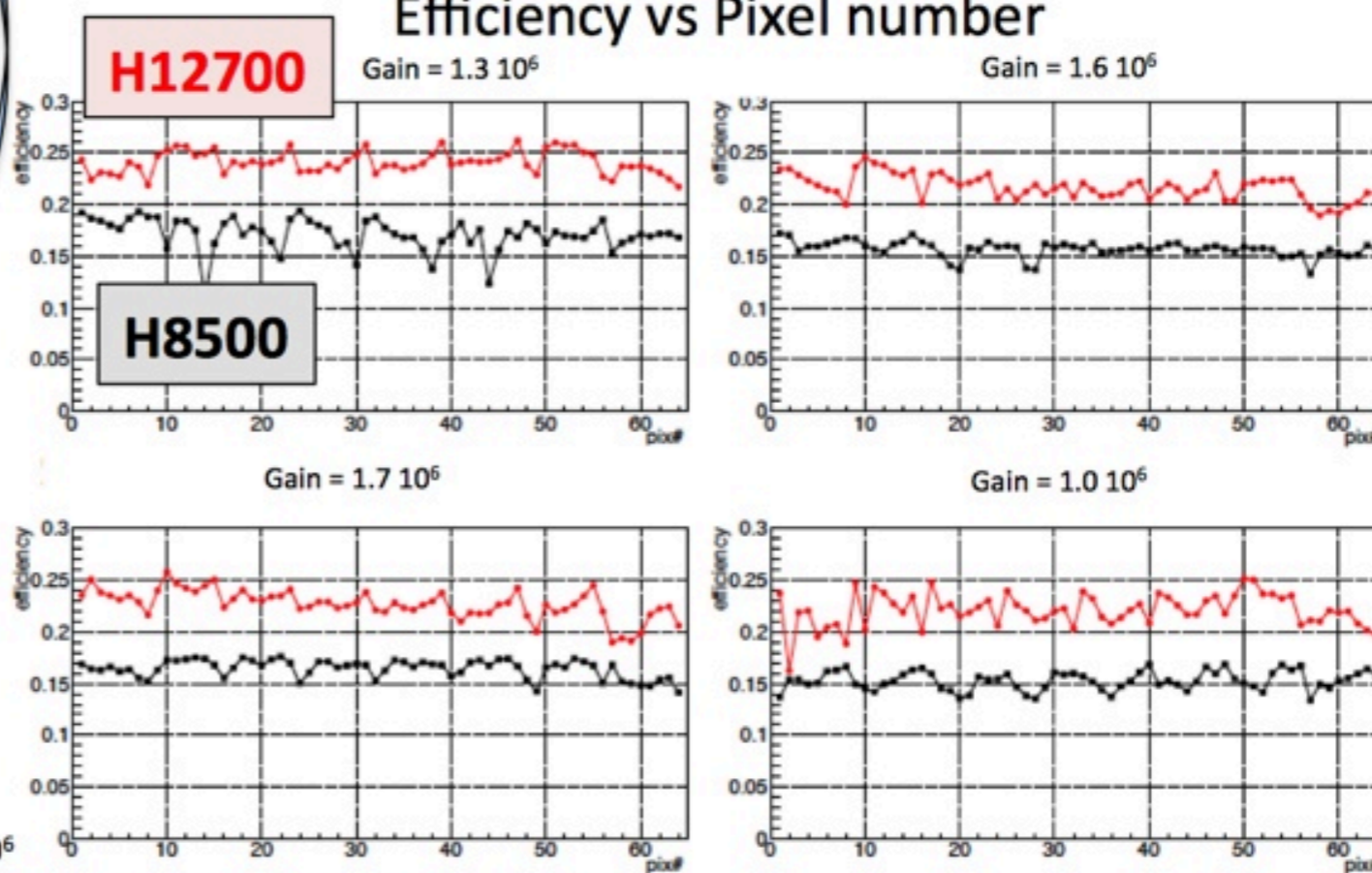

Comments from EIC meeting

- * Need to be thinking about effects of solenoid fringe field
 - * Not a show stopper, but should consider measuring the field in this region and shielding options
- * Timeline for H12700s:
 - * CLAS12 expected to complete their H12700 order by April 2016
 - * CBM RICH project at GSI recently ordered ~500 H12700s
 - * Likely ties up Hamamatsu for another ~1 year
 - * What is the impact on our schedule?

Magnetic field near DIRC readout

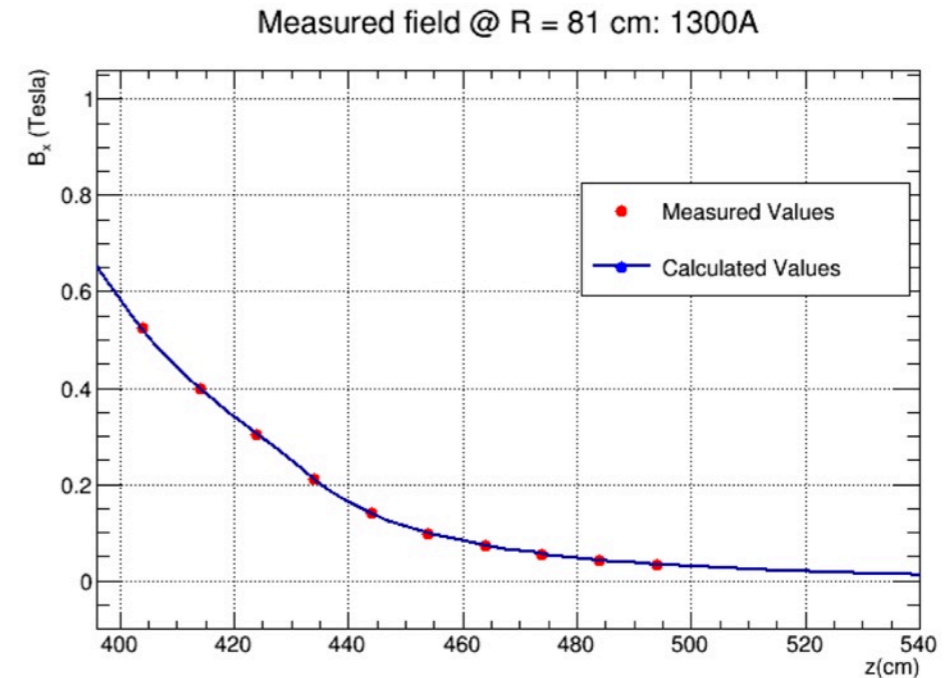
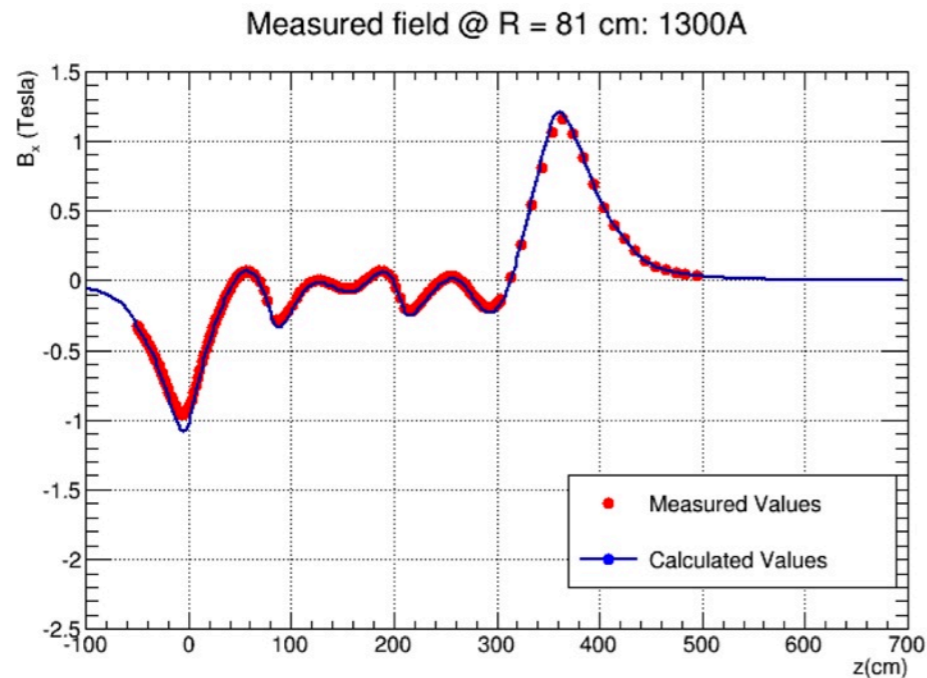

- * POISSON model of solenoid field provides good description at large radii for up to $z = 500$ cm
- * Use POISSON to estimate field in MaPMT plane region ($650 < z < 680$ cm)
- * Should we plan to measure the field in this region?

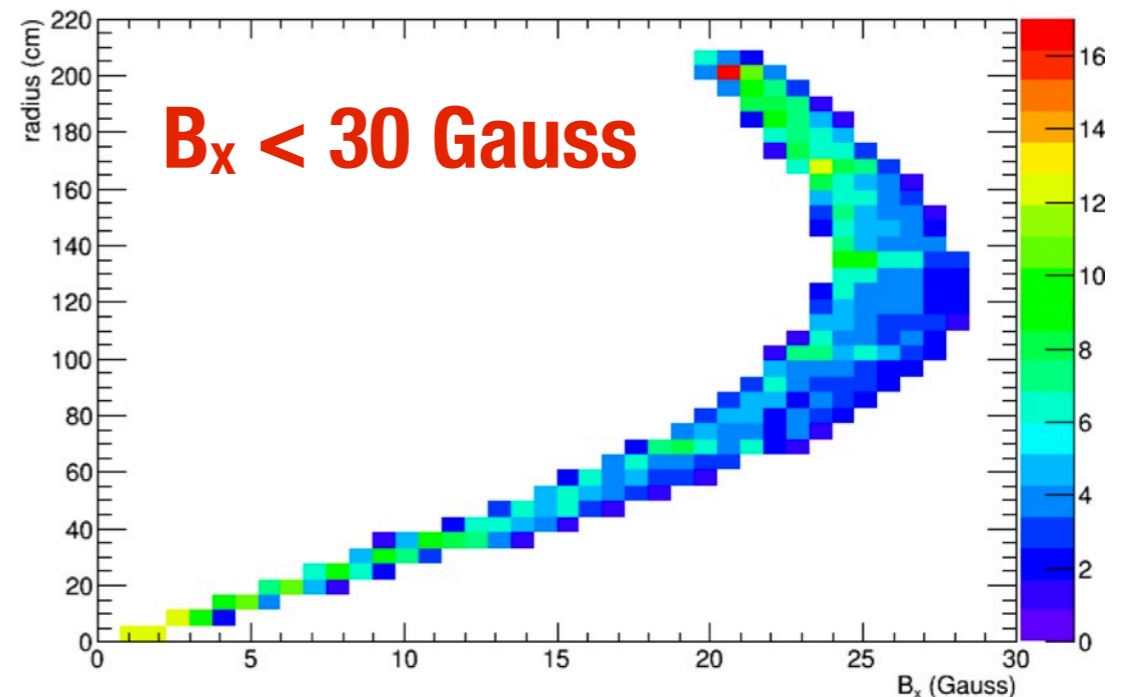
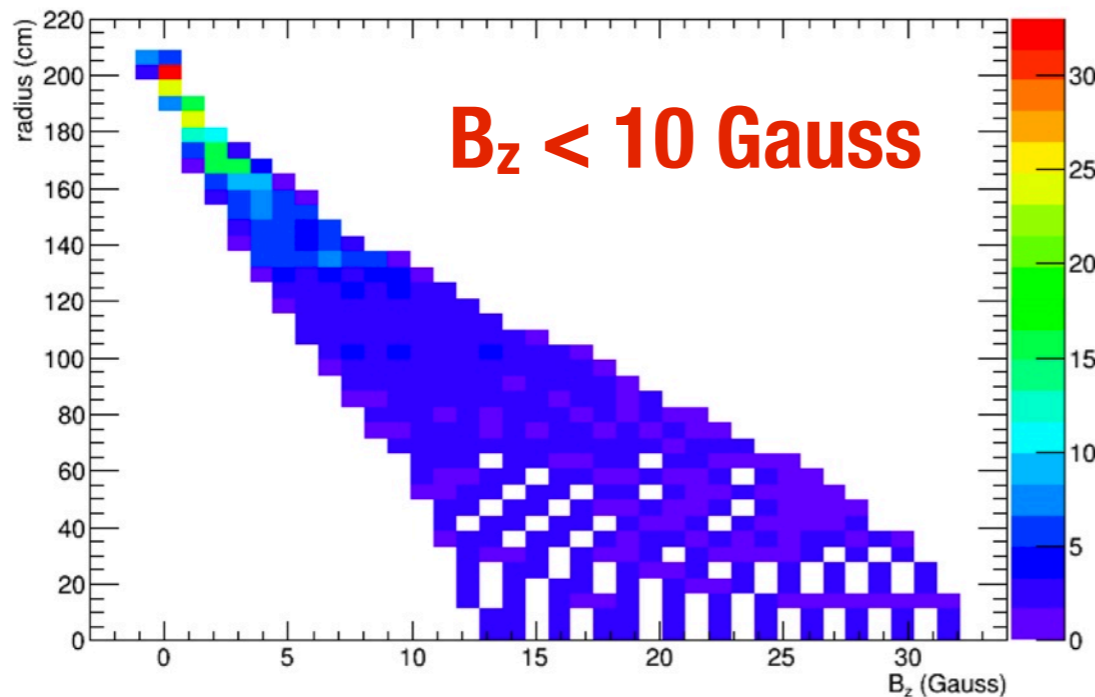

Magnetic field tests

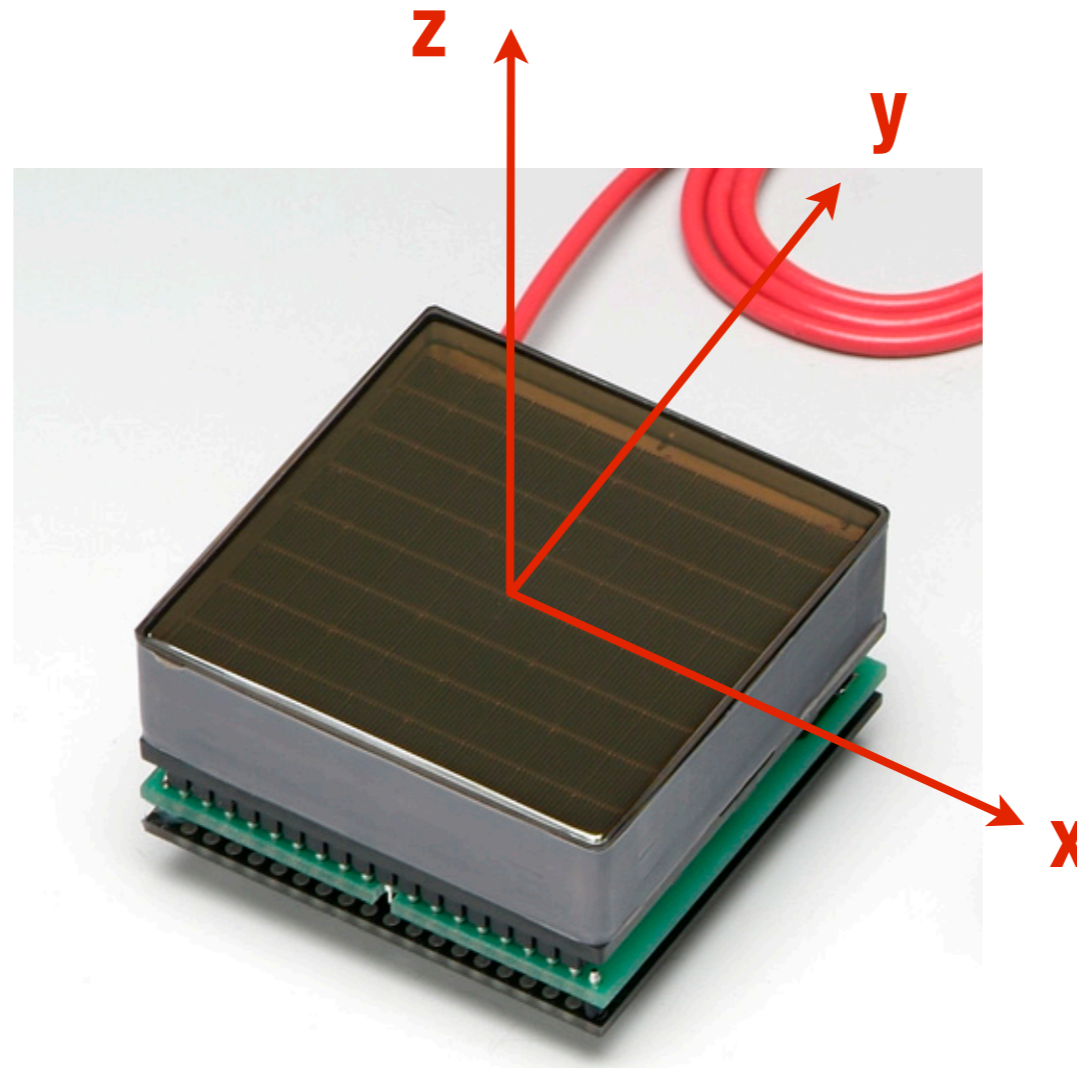

- ✱ Setup with fields longitudinal (z) and transverse (x and y)
- ✱ Doesn't easily translate to Hall D coordinate system since PMT plane at an angle

SOLID longitudinal field tests

Central
pixel

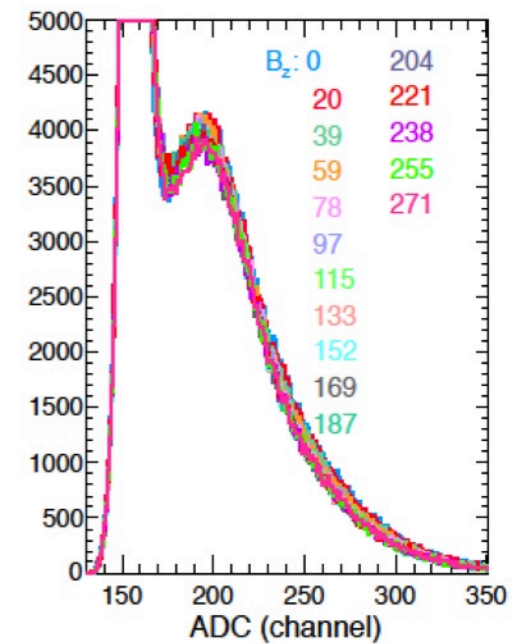
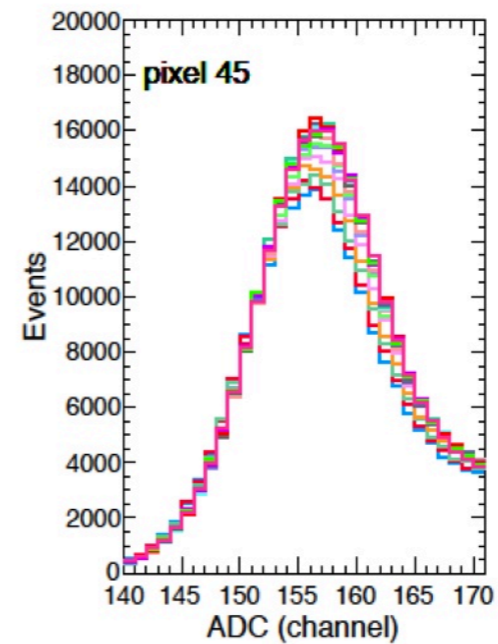
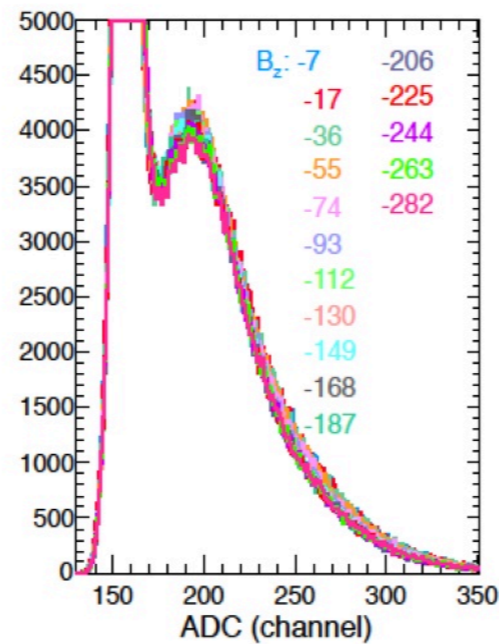
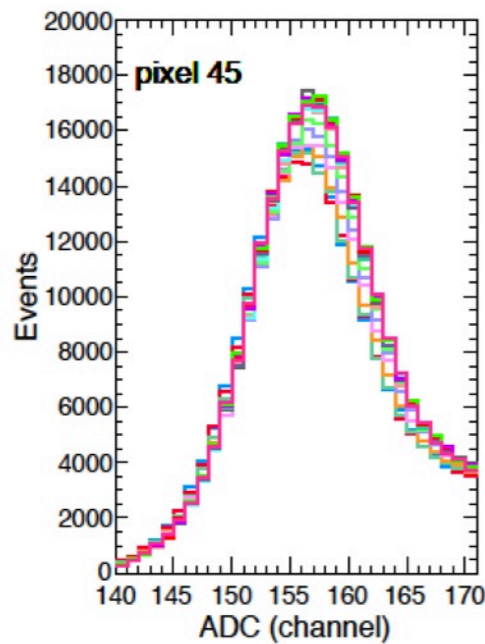

Edge
pixel

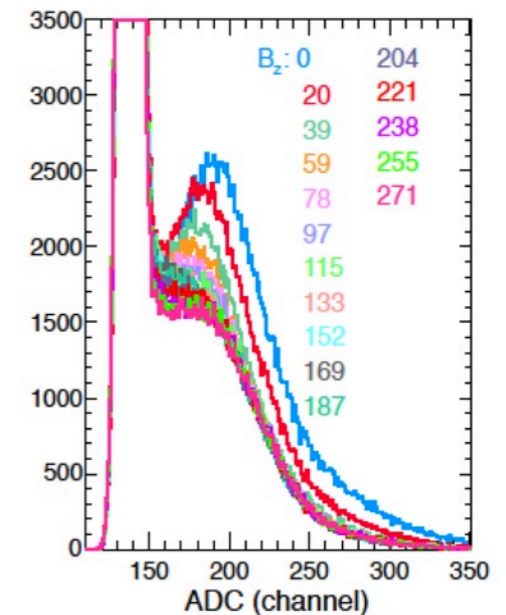
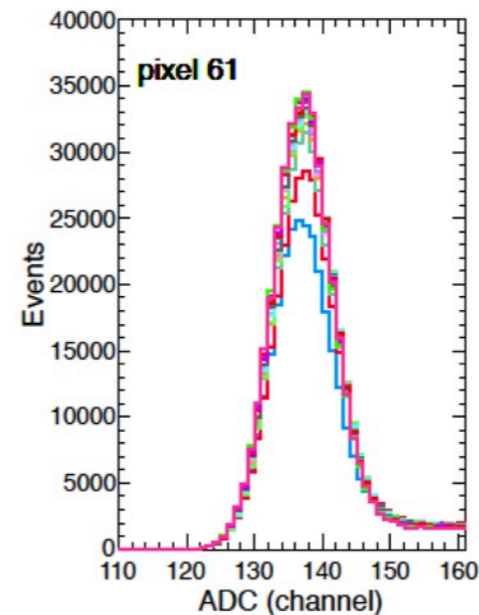
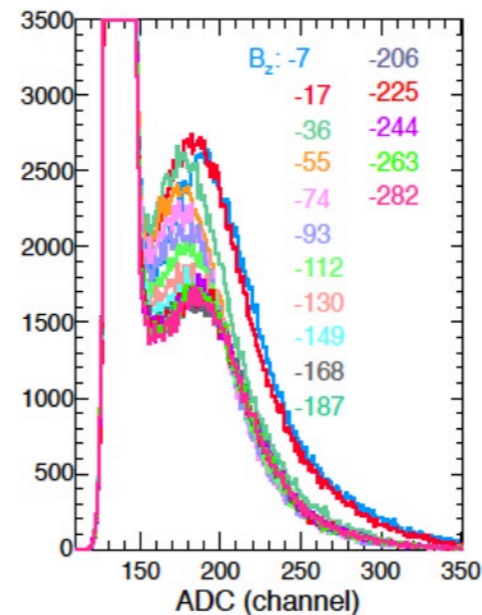
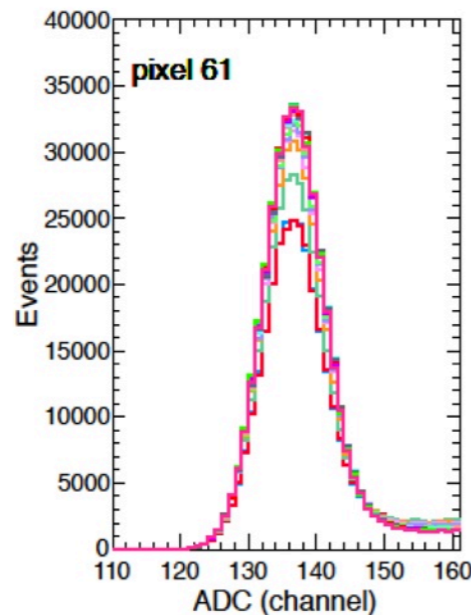

- * Test of one older model H8500 for SOLID Cherenkov [2013 JINST 8 P09004](#)
- * Evaluated performance for central pixel and edge pixel

SOLID transverse field tests

Central
pixel

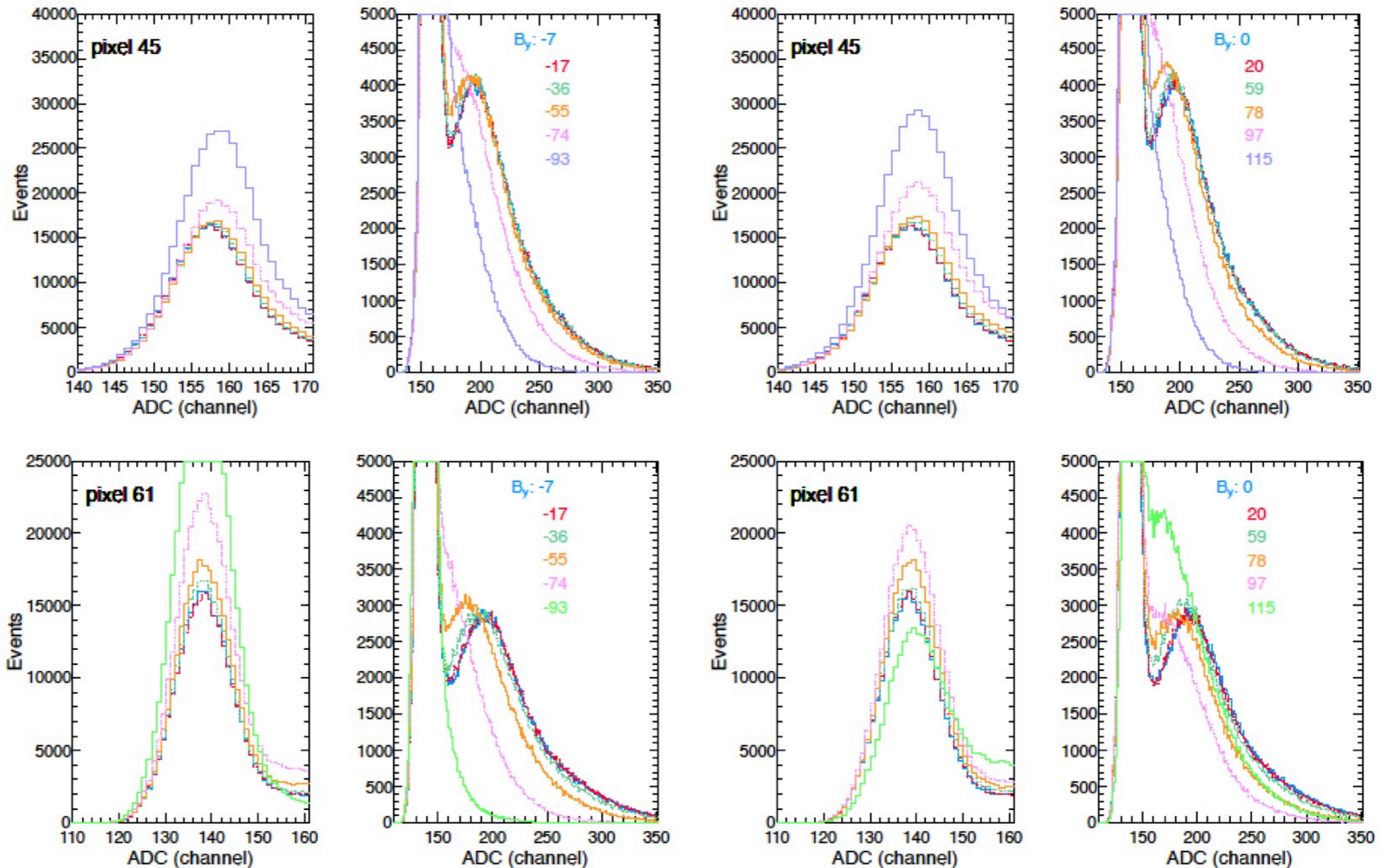

- * Test of one older model H8500 for SOLID Cherenkov [2013 JINST 8 P09004](#)
- * Evaluated performance for central pixel and edge pixel

Longitudinal field summary

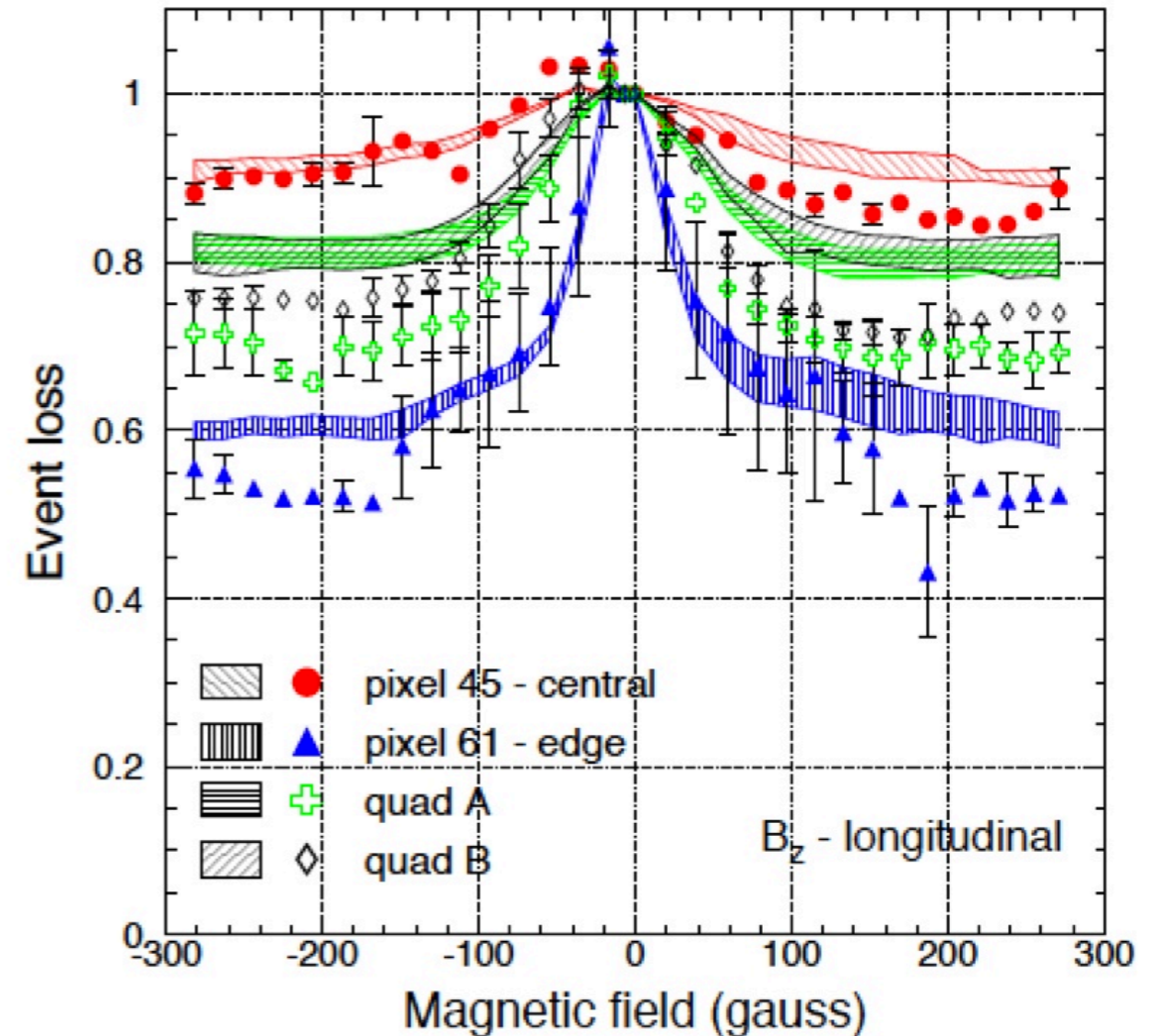
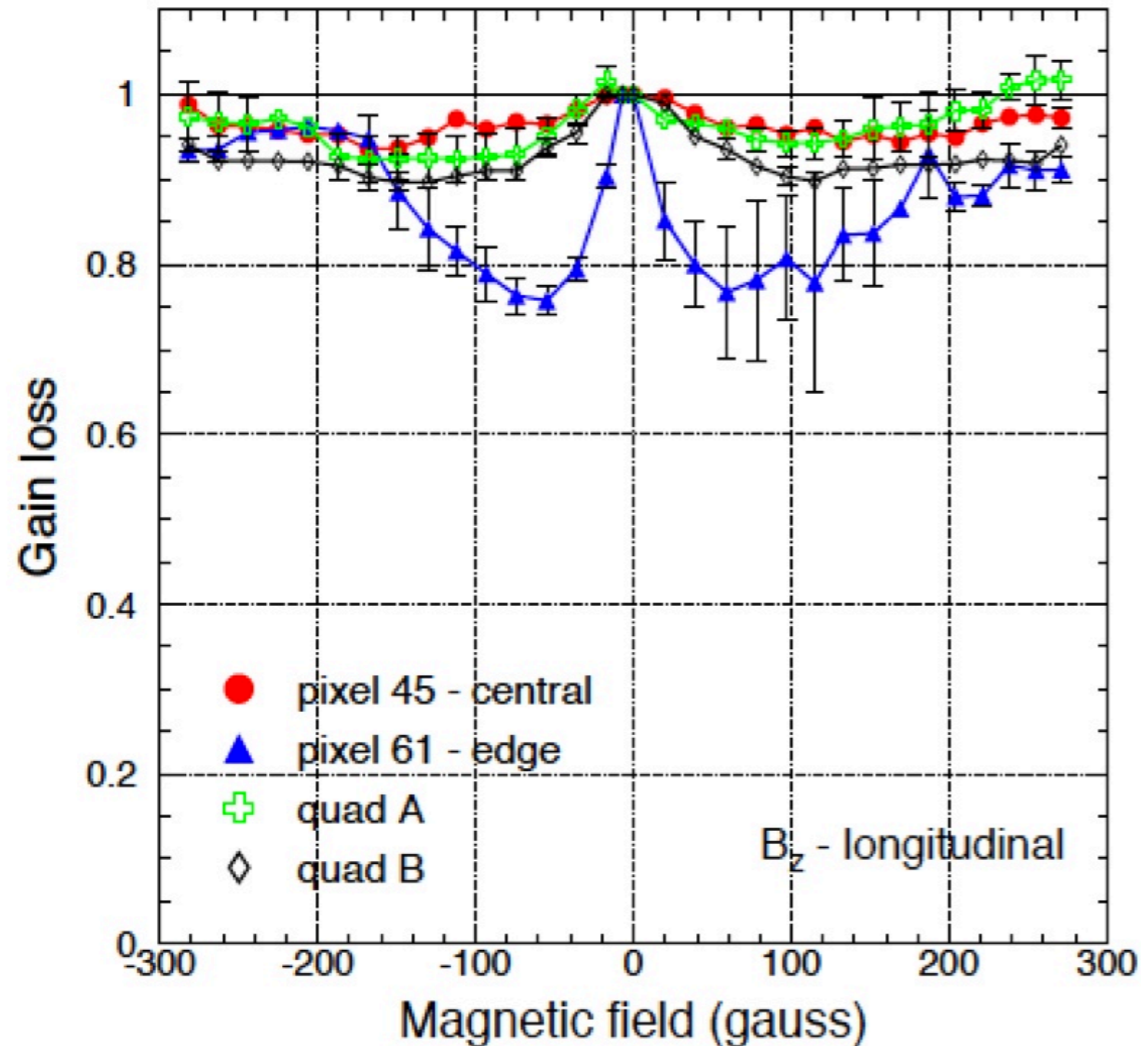

- * Test of one older model H8500 for SOLID Cherenkov [2013 JINST 8 P09004](#)
- * Evaluated performance for central pixel and edge pixel

CLAS12 field tests

- * Expect small fields (<5 Gauss) in region of RICH readout
- * Tested of H8500 in [arXiv:1409.3622](https://arxiv.org/abs/1409.3622)
- * Only transverse field settings
- * Planning for tests with H12700?

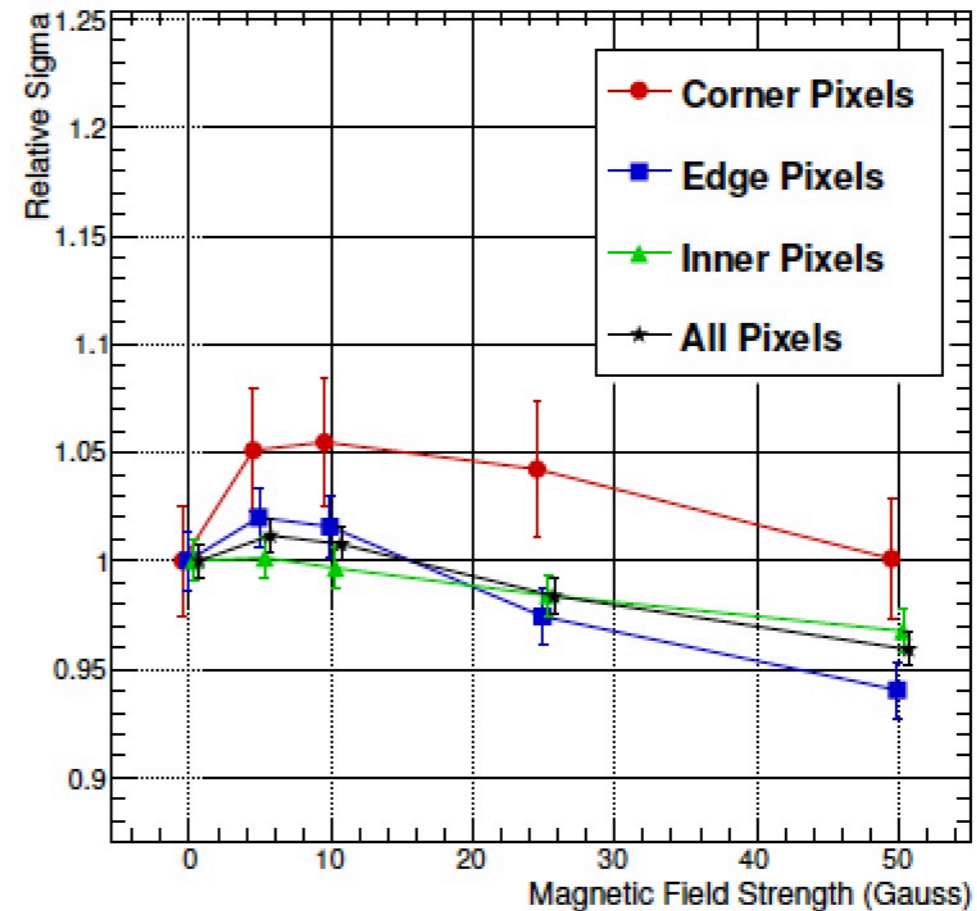
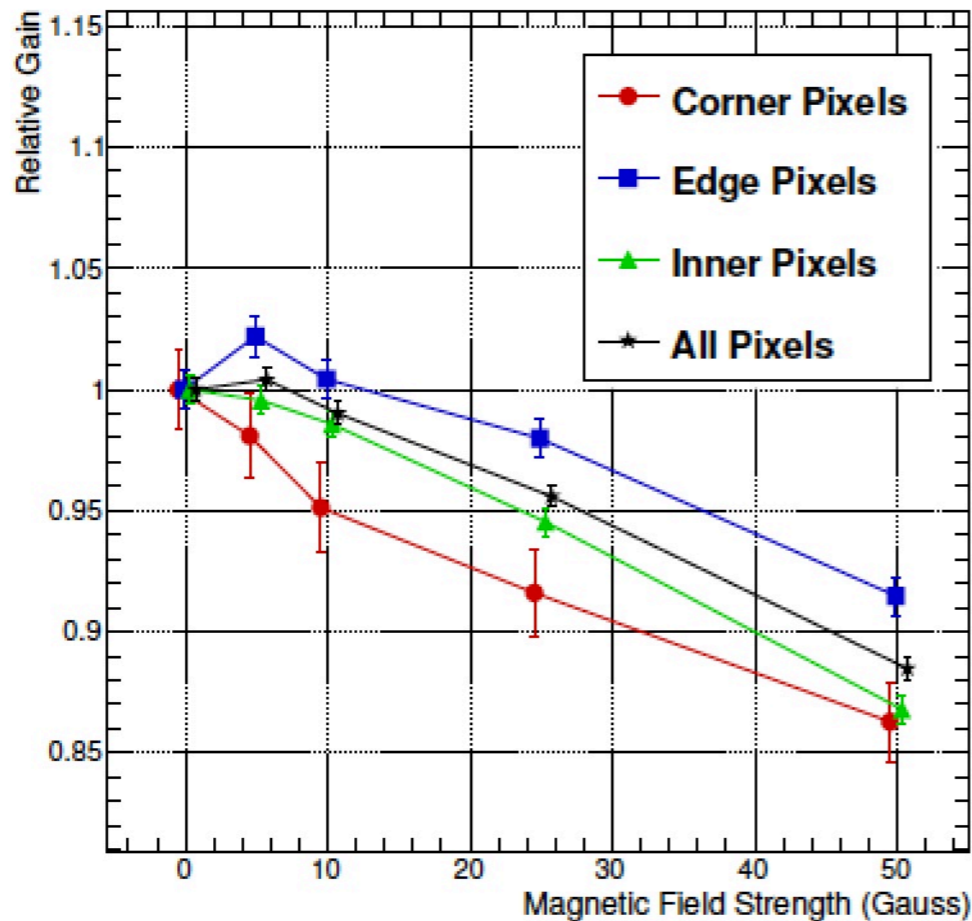
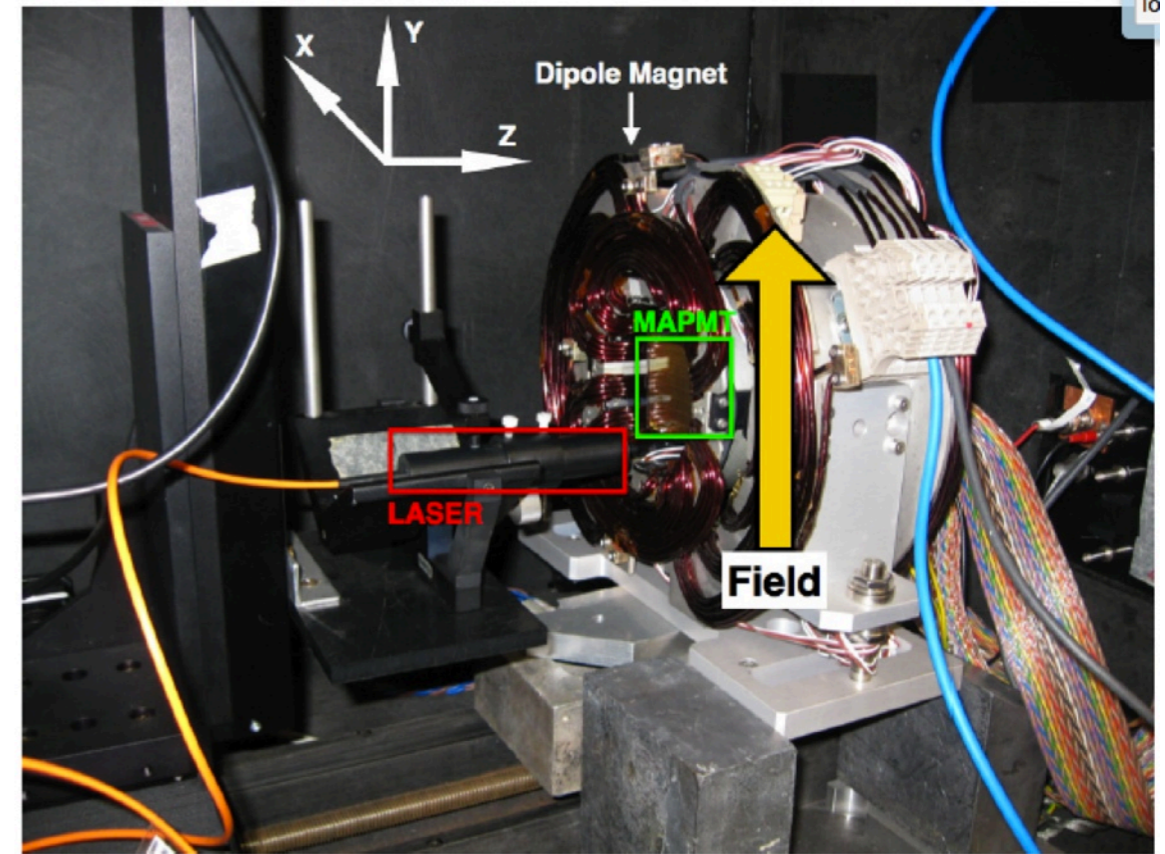

Readout electronics



- * MAROC3 chip provides binary hit only (no ADC) with time resolution of ~1 ns
- * CLAS12 evaluated single photon response utilizing slow ADC (could be used in calibration)
- * Will be discussing more with Fernando next week about the required specs

Bipolar Output of MAROC Slow Shaper

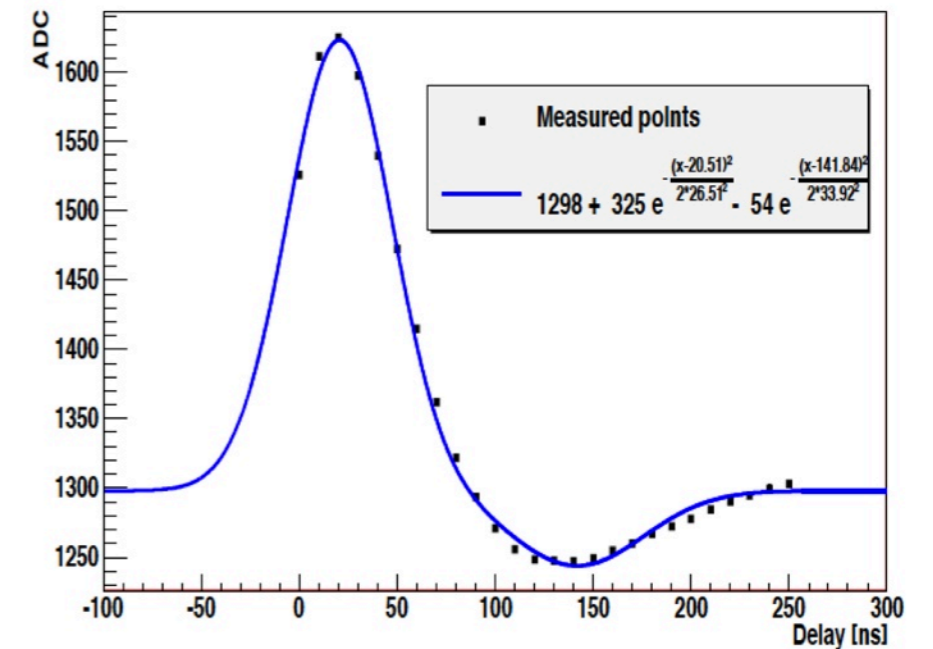

“unit” gain

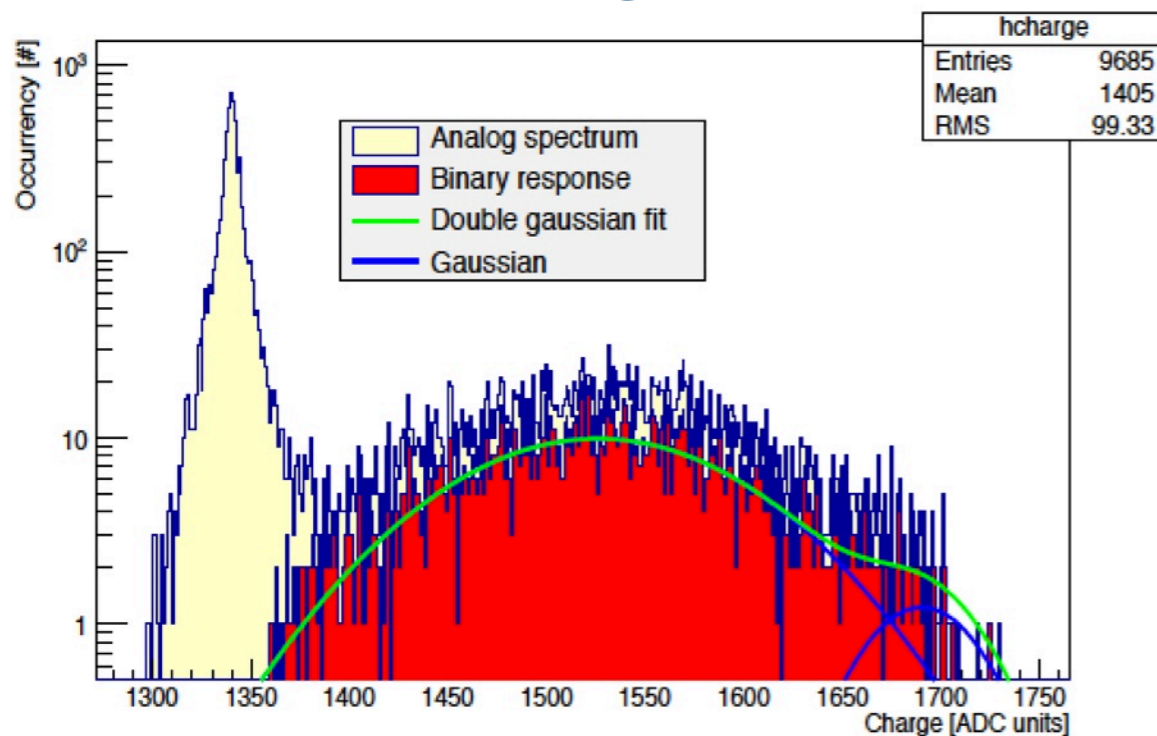

4x higher gain

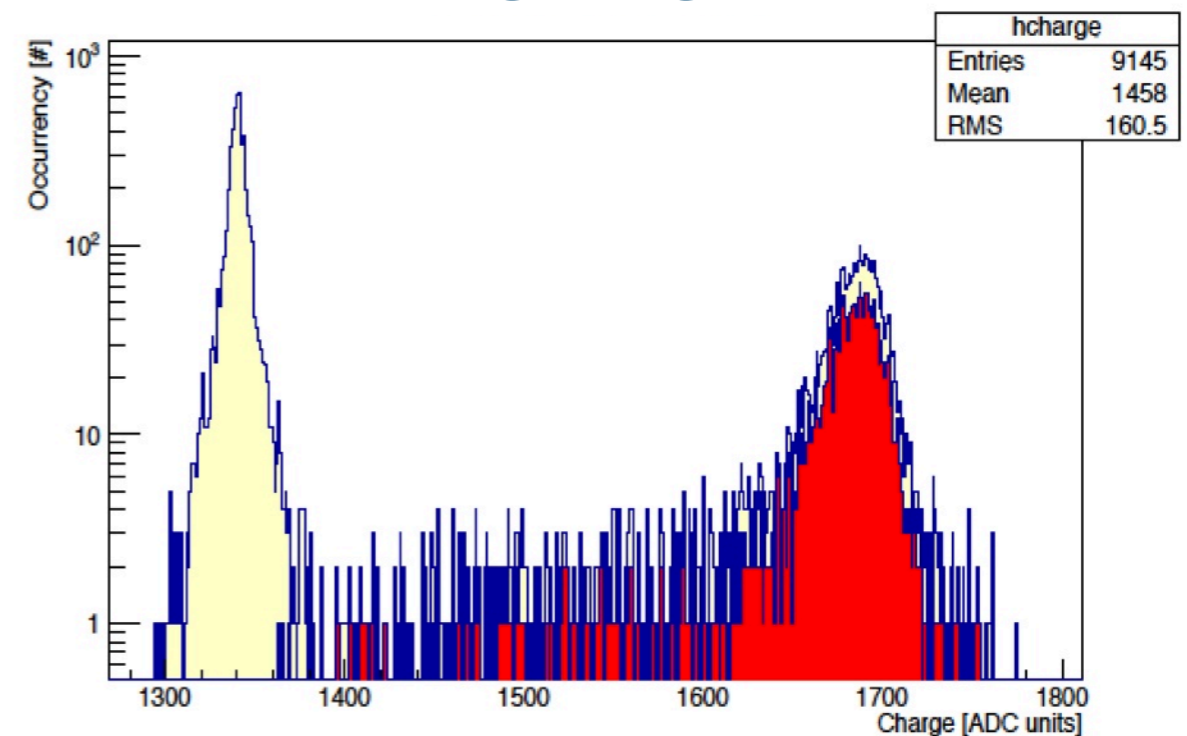

Update on readout cost estimate

- * Cost estimate for readout previously based on MCP-PMTs (\$336K total)
- * Total project cost will be driven by readout costs (\$2.6K per MaPMT)
- * Optimize optics to reduce PMT plane size?
 - * Need to instrument between two halves of detector?

CLAS12 RICH: 400 MaPMTs

Readout base costs (K\$) for 400 or 220 MaPMTs

	400	220
MaPMT	1023.4	562.9
DAQ	243.2	133.7
FEE	180.1	99.1
Total	1446.7	795.7

	Base Cost (K\$)	Cont. (%)	Cost Cont. (K\$)	TOTAL Cost (K\$)	JLab	INFN	CHILE
MA-PMTs	1023,4	20	204,7	1228,1	1228,1		
Aerogel	550,8	30	165,2	716	253	463	
DAQ electronics	243,2	10	24,3	267,5	267,5		
Front End Electronics	180,1	25	45	225,1		225,1	
Mechanics	55,5	10	5,6	61,1	13,75	47,3	
Mirrors	436,5	30	131	567,5		267,5	300
Gas System	20	30	6	26	26		
Slow Control	10	30	3	13	13		
Shipment	20	30	6	26		26	
TOTAL	2539,5		590,8	3130,3	1801,4*	1028,9**	300***

Readout close to total material cost from PAC proposal:

Total estimated material cost \$831

Hits on readout plane from bggen

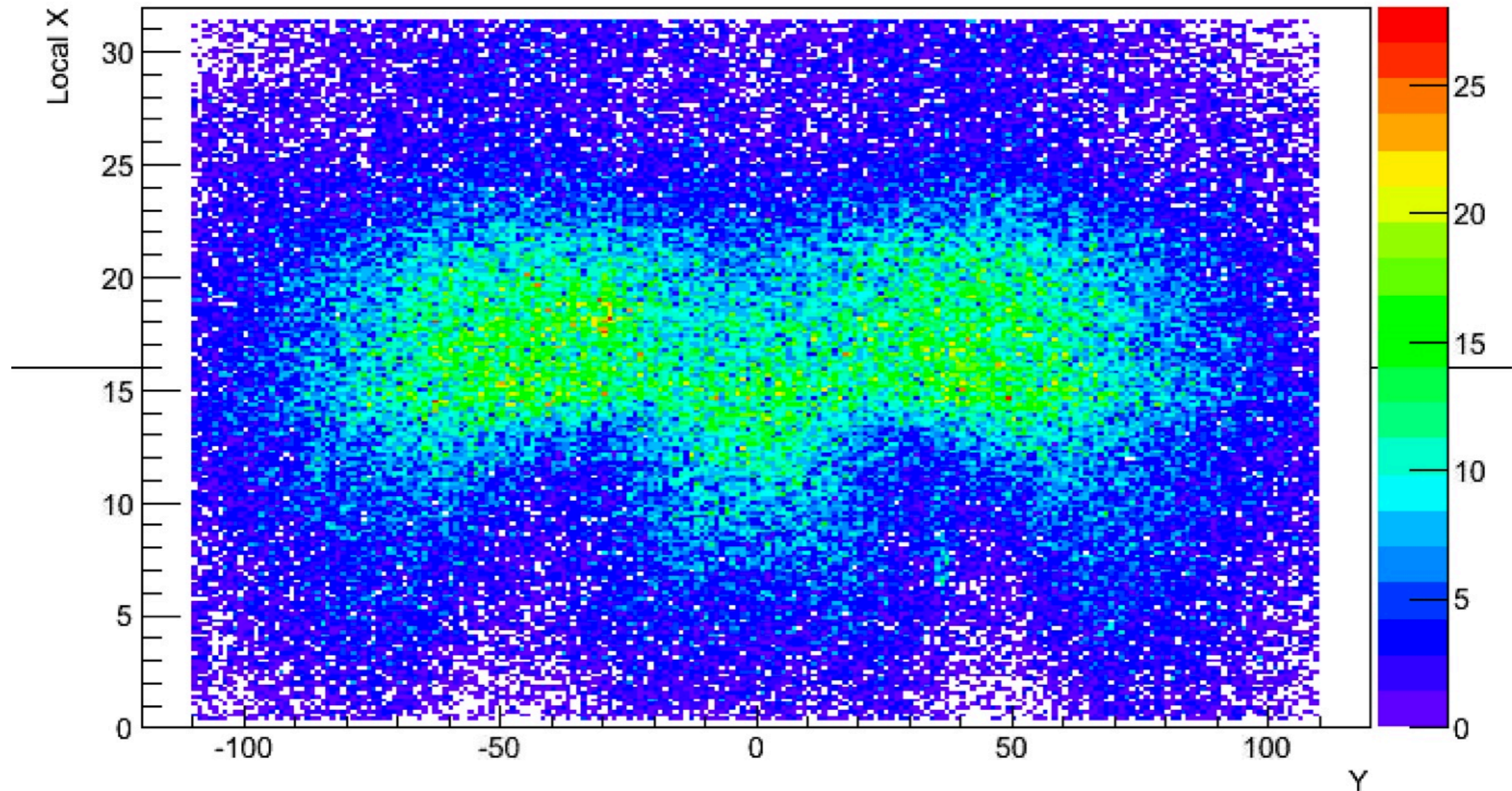

- * Need ~220 MaPMTs to cover 220 cm x 25 cm from cylindrical mirror optics
- * Some regions don't require PMTs, but height of the PMT plane required drives the cost

Hits on readout plane from single track

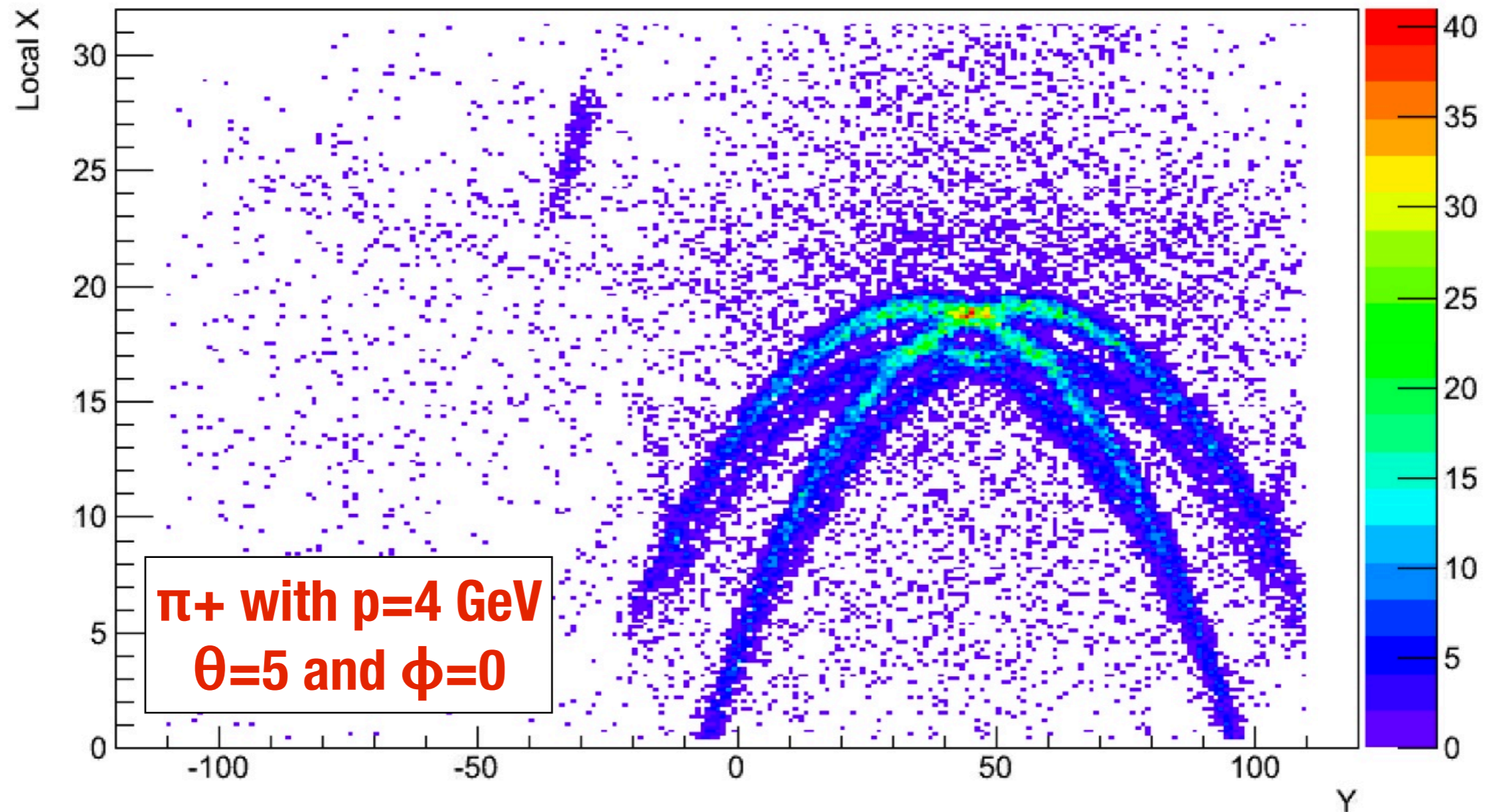

- * Need ~ 220 MaPMTs to cover 220 cm x 25 cm from cylindrical mirror optics
- * Some regions don't require PMTs, but height of the PMT plane required drives the cost

Cylindrical vs 3-segment

Cylindrical

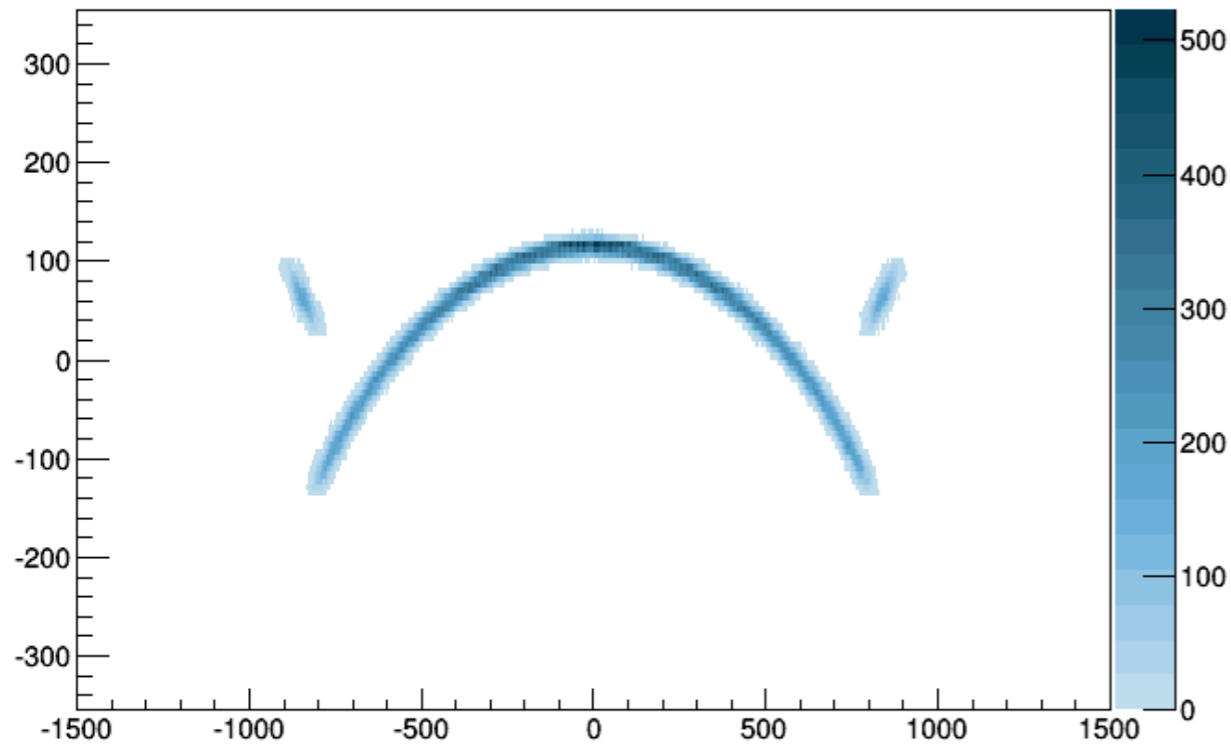

3-segment

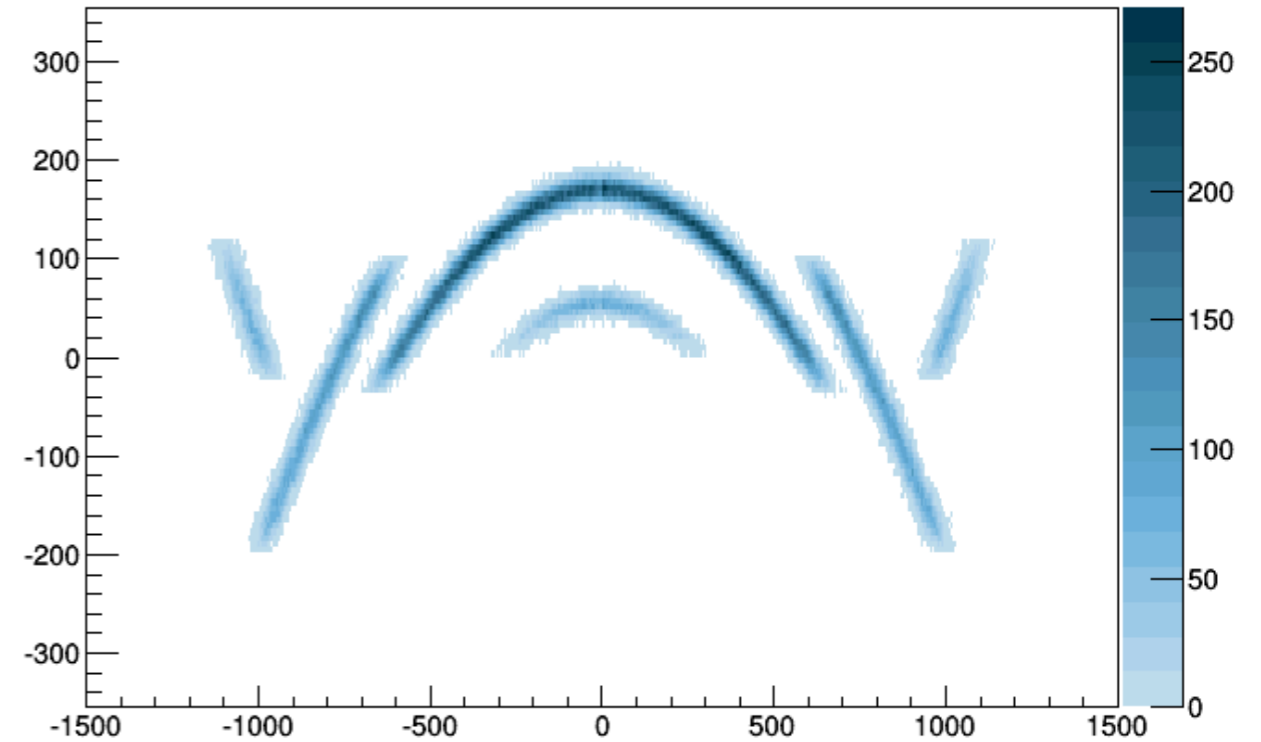

- * Height increased from 25 \rightarrow 40 cm, is a serious increase in cost
- * Is there room for optimization with 3-segment mirror angles

Future plans

- * Design review planned for early October 2015
- * External reviewers and DOE sitting in
- * Planning to prepare Conceptual Design Report for review based on PAC proposal and pre-R&D
- * Plan to allocate capital equipment funds FY16-18
- * Total project cost below \$2M